

SPECIFICATION	PREPARED BY:	K.Kuramoto	R E V A	M.Miyashita				
	CHECKED BY:	M.Miyashita		K.Kuramoto				
	APPROVED BY:	K.Mori		K.Mori				
	DATE:	Mar.31, 2015		Sep.20, 2016				

1. Type	ML562G84-01
2. Application	Light Source
3. Structure	Red Laser Diode
4. Outline	G880367

5. Absolute maximum ratings

No.	PARAMETER	SYMBOL	CONDITION	RATINGS	UNIT
(1)	Operation Current	I _{op}	Pulse(Duty Cycle ≤ 40%)	Fig.1	
(2)	Reverse Voltage	V _{RL}	-	2	V
(3)	Anode-Case Voltage (*1)	V _{ac}	-	-200~200	V
(4)	Operating Case Temperature	T _c	-	0~+55	°C
(5)	Storage Temperature	T _{stg}	-	-40~+85	°C
(6)	Soldering Temperature	T _{sol}	Lead Length ≥ 2mm	320°C, 2sec	

<Note> The maximum rating means the limitation over which the laser should not be operated even instant time, and this does not mean the guarantee of its lifetime. As for the lifetime, refer to the reliability report from Mitsubishi Semiconductor Quality Assurance Section.

*1: Voltage between Φ9 package and anode lead pin

6. Characteristics table

No.	PARAMETER	SYMBOL	CONDITION (T _c =25°C(*2) unless otherwise specified)	LIMITS			UNIT
				MIN.	TYP.	MAX.	
(1)	Output Power	P _{op}	Pulse(*3), I _{op} =2.8A, T _c =25°C	2.3	2.5	-	
			Pulse(*3), I _{op} =3.6A, T _c =45°C	2.3	2.5	-	
			Pulse(*3), I _{op} =3.6A, T _c =55°C	1.6	1.9	-	
(2)	Threshold Current	I _{th}	Pulse(*3), T _c =25°C	640	780	860	mA
(3)	Operating Voltage	V _{op}	Pulse(*3), I _{op} =2.8A, T _c =25°C	2.1	2.4	2.5	V
(4)	Slope Efficiency	η	Pulse(*3), T _c =25°C	1.1	1.25	1.5	W/A
(5)	Peak Wavelength	λ _p	Pulse(*3), I _{op} =2.8A, T _c =25°C	636	638	642	nm
(6)	Beam Divergence (Full Width at 1/e ²)	θ _{//}	Pulse(*3), I _{op} =2.8A, T _c =25°C	6	8	10	°
		θ _⊥	Pulse(*3), I _{op} =2.8A, T _c =25°C	60	70	80	°

*2: Actual measurement temperature is adjusted in order to match an active layer temperature to that of stable condition at T_c=25°C.

*3: Pulse condition 120Hz, Duty=30%

These specifications are based on MITSUBISHI's method.

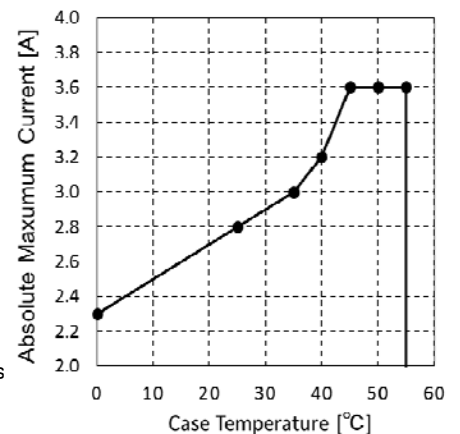

Fig.1 Absolute maximum ratings of operating current

SPECIFICATION

7. LD packing specification

7-1. This specification is applied to **ML562G84-01** packing.

(1) Each laser diode is packed in the individual envelope, Al coated of inside.

Tested data, I_{th} , V_{op} , P_{op} , λ_p , $\theta_{//}$, θ_{\perp} at $I_{op} = 2.8A$ pulse, $T_c = 25^{\circ}C$ (equivalent) are indicated on the envelope.

(2) Please refer to the example of the envelope.

Envelope (inside)



Envelope (outside)

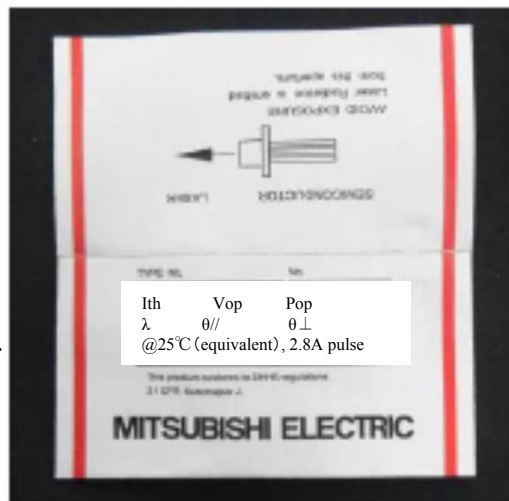

<Back>

<Front>

(3) The envelopes are packed into the box as below.

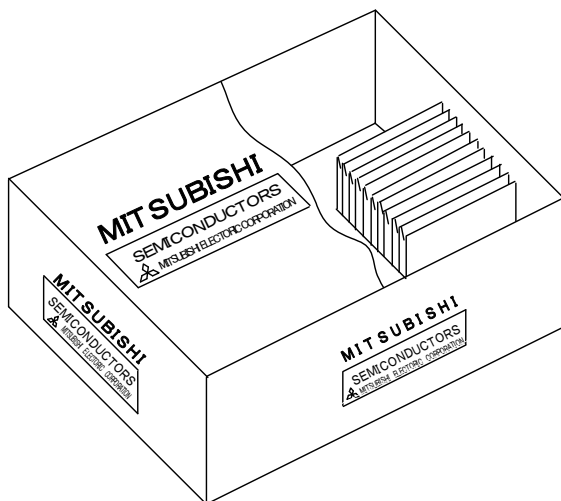

Packing box

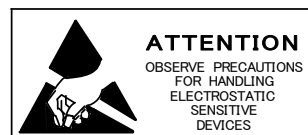
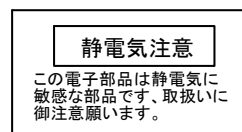

SPECIFICATION

8. Safety precautions relating to handling of optical semiconductor devices**General:**

Although manufacturer is always striving to improve the reliability of its products, problems and errors may occur with semiconductor devices. Hence, it is necessary that user's own products are designed with full regard to safety by incorporating redundancy, fire prevention, and error prevention, so any problems or errors with semiconductor device do not cause accidents, which might result in injury, death, fire, or environmental hazard. The following requirements must be strictly observed.

Warning!**1. Safety standard of laser devices**

Please follow closely to international standard (e.g. IEC 60825-1) or standard of each country (ex. JIS C 6802 in Japan).

2. Laser characteristics and its danger

When laser device is operated at over-driven condition, low temperature, pulsing mode, and so on, it could emit higher optical power than absolute maximum rating, and peak optical power might increase in conjunction with relaxation oscillation. Laser device could lase at different wavelength with different case temperature, or different output power. Laser devices are deviated on threshold current, operating current, operating voltage, slope efficiency, peak wavelength, beam divergence, and so on. Not only light output power, but also polarization or far field patterns might change as operating time goes by. If customers need more information of laser device, please contact Mitsubishi Electric.

Laser light from each device might seriously injure human eyes and skin. Customer should design and manufacture carefully their application products based on not only laser light characteristics but also LD characteristics, in order to avoid human injury. Mitsubishi Electric is not responsible for any accidents that are caused by customer's products.

If customers plan to release medical or aesthetic products with laser device, they should obtain their government's laser safety authorization.

3. Avoid laser light from entering human eyes

In normal operation, semiconductor laser device emits laser light. Laser light entering eyes could cause extreme damage. Never look against laser beam direction, and never look directly through an optical system such as a lens. Use an ITV camera to observe laser light. Mitsubishi Electric recommends that customers should explicitly label their laser products with warning sign of eye injury.

4. Handling of device

Gallium arsenide (GaAs) and beryllium oxide (BeO) are used in laser device. To avoid danger, strictly observe the following cautions:

Never place the device in human mouth. Never burn or break the device. Never use any type of chemical treatment to reduce it to gas or powder. When disposing device, always follow any applicable laws, as well as customer's internal waste treatment regulations.

5. Disposal of device

Laser device uses Gallium arsenide (GaAs) and beryllium oxide (BeO). It should be disposed as a specially controlled industrial waste, and it should be separated from general industrial and household wastes, according to any "Law of Wastes and Cleaning".

Caution!**1. High temperature**

During operation device may become hot, therefore do not directly touch it during operation. The device could remain hot even after power is turned off, so wait until it cools down prior to touching to avoid any burn. Never place any inflammable substance that may cause fire near the device.

SPECIFICATION

9. Handling Cautions for Optoelectronic Devices**1. General**

(1-1) The products described in this specification are designed and manufactured for use in general communication systems or electronic devices, unless their applications or reliability are otherwise specified. Therefore, they are not designed or manufactured for installation in devices or systems that may affect human life or that are used in social infrastructure requiring high reliability.

(1-2) When the customer is considering to use the products described in this specification in special applications, such as transportation systems (automobiles, trains, vessels), medical equipments, aerospace, nuclear power control, and submarine repeaters or systems, please contact Mitsubishi Electric or an authorized distributor.

2. Storage Conditions

When storing the products, it is recommended to store them following the conditions described below without opening the packing. Not taking enough care in storing may result in defects in electrical characteristics, soldering quality, visual appearance, and so on. The main points are described below (if special storage conditions are given to the product in the specification sheet, they have priority over the following general cautions):

(2-1) Appropriate temperature and humidity conditions, i.e., temperature range between 5~35°C, and humidity between 45~75 percent RH, should be maintained in storage locations. Controlling the temperature and humidity within this range is particularly important in case of long-term storage for six months or more.

(2-2) The atmosphere should be particularly free from toxic gases and dust.

(2-3) Do not apply any load on the product.

(2-4) Do not cut or bend the leads of the devices which are to be stored. This is to prevent corrosion in the cut or bent part of the lead causing soldering problems in the customer's assembling process.

(2-5) Sudden change in temperature may cause condensation in the product or packing, therefore, such locations should be avoided for storing. Temperature in storage locations should be stable.

(2-6) Storage conditions for cap-less products shall be stated separately because these products require stricter controls than package sealed products.

3. Design Conditions and Environment under Use

(3-1) Operation in excess of the absolute maximum ratings can cause permanent damage to the device. The customers are requested to design not to exceed those ratings even for a short time.

(3-2) Avoid use in locations where water or organic solvents adhere directly to the product, or where there is any possibility of the generation of corrosive gas, explosive gas, dust, salinity, or other troublesome conditions. Such environments will not only significantly lower the reliability, but also may lead to serious accidents.

(3-3) Contamination to cap window or LD emitting point by volatile material, such as adhesive, may degrade reliability. When you use adhesive material, we recommend you to confirm possible effect before usage.

(3-4) Quality assurance for cap-less products shall be stated separately because these products require more notice in your line and your products environment than package sealed products.

4. Static Electric Safety Cautions

The optoelectronic devices are sensitive to static electricity (ESD, electro-static discharge). The product can be broken by ESD. When handling this product, please observe the following countermeasures:

<Countermeasures against Static Electricity and Surge>

To prevent break of devices by static electricity or surge, please adopt the following countermeasures in the assembly line:

(4-1) Ground all equipments, machinery jigs, and tools in the process line with earth wires installed in them. Take particular care with hot plates, solder irons and other items for which the commercial power supplies are prone to leakage.

(4-2) Workers should always use earth bands. Use of antistatic clothing, electric conductive shoes, and other safety equipment while at work is highly recommended.

(4-3) Use conductive materials for this product's container, etc.

(4-4) It is recommended that grounding mats be placed on the surfaces of assembly line workbench and the surrounding floor in work area, etc.

(4-5) When mounting this product in parts or materials which can be electrically charged (printed wiring boards, plastic products, etc.), pay close attention to the static electricity in those parts. ESD may damage the product.

(4-6) Humidity in working environment should be controlled to be 40 percent RH or higher.

These countermeasures are most general, and there is a need to carefully confirm the line using this product. It is extremely important to prevent surge, eliminate it rapidly, and prevent it from spreading.

記録

番号 NUMBER	品名 DESCRIPTION	材料 MATERIAL	備考 REMARKS
01	Base	SPC	
02	Cap	45Ni-Fe	
03	Window	Glass	Refractive Index $\cong 1.5$
04	Laser Diode Chip	GaAs-Base	

Positional accuracy of the emitting point

$|\Delta X|, |\Delta Y|, |\Delta Z|$ 0.08mm

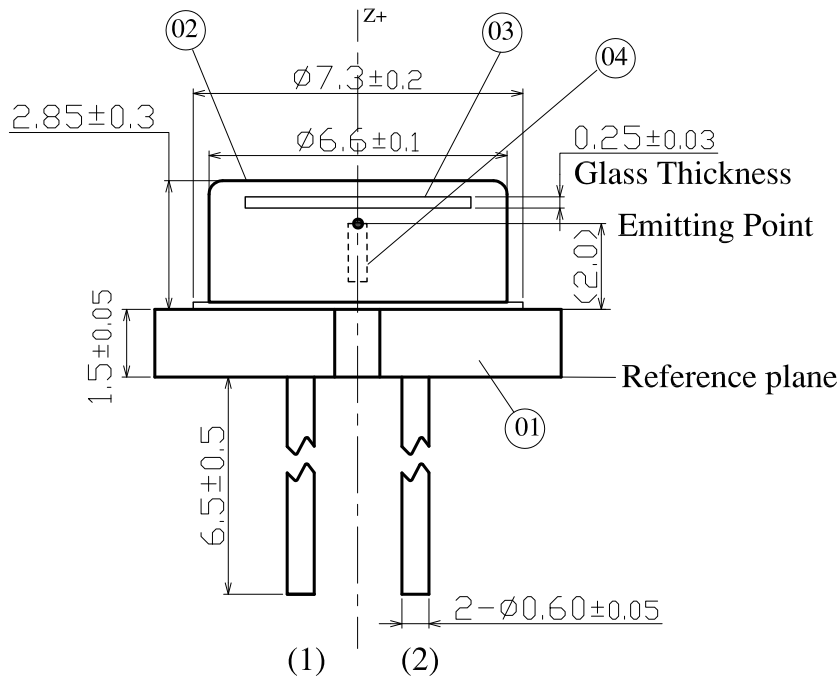
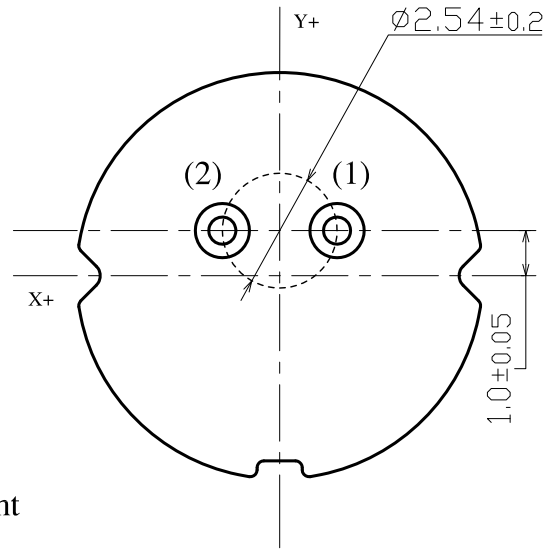
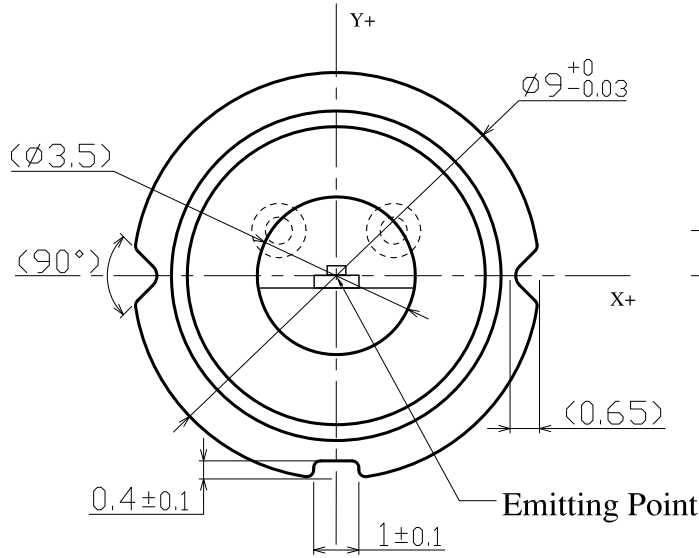

Pin connection

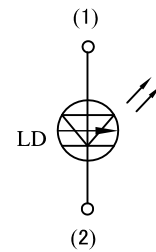

改定 CHANGE
Position of reference plane is changed from top to bottom of base.
M.Miyashita
K.Kuramoto
T.Nishida Oct.13, 2016

常用
保留
一時
商用

第3角法 3RD ANGLE PROJECTION

MITSUBISHI ELECTRIC CORPORATION

OUTLINE DRAWING
62G pkg (Pb-free)

DIM IN (mm)
尺度 SCALE 10/1 NTS

作成 DRAWN 照査 CHECKED 設計 DESIGNED 検認 APPROVED

作成日付 DATE '14-12/16

M.Mametani M.Miyashita K.Kuramoto K.Mori Feb.2, 2015

G

880367

控出図先