

## DESCRIPTION

AMCOM's AM00012033TM-SN-R is a broadband GaN MMIC power amplifier. It has 14dB gain, and 41 dBm output power over the DC to 12GHz band. The AM00012033TM-SN-R is in a ceramic package with a flange and straight RF and DC leads for drop-in assembly. Because of high DC power dissipation, good heat sinking is required. The package is RoHS compliant. This MMIC is matched to 50 Ohms.

## FEATURES

- Ultra-Broadband from DC to 13GHz
- Saturated output power Psat is 36dBm
- Gain, 14dB
- Input & output matched to 50 Ohms

## APPLICATIONS

- Instrumentation
- Commercial telecom transmission equipment
- Fixed microwave backhaul

## TYPICAL PERFORMANCE \*

Parameters	Minimum	Typical **	Maximum
Frequency	0.5 – 10 GHz	DC – 12 GHz	
Small Signal Gain	11dB	14dB	17dB
Gain Ripple		± 2dB	± 5.0dB
P1dB (0.5 – 4.0GHz)	-	28dBm	
P1dB (4.0 – 8.0GHz)	-	26dBm	
P1dB (8.0 – 12.0GHz)	-	24dBm	
Psat (0.5 – 4.0GHz)	33dBm	35dBm	
Psat (4.0 – 8.0GHz)	31dBm	33dBm	
Psat (8.0 – 12.0GHz)	27dBm	29dBm	
Psat Efficiency		15%	
Noise Figure		TBD	
IP3		TBD	
Input Return Loss	7dB	>10dB	
Output Return Loss	7dB	>10dB	
Thermal Resistance		TBD	

\* Specifications subject to change without notice.

\*\* Bias Conditions\*\*:  $V_{ds1} = 28V$  ,  $I_{ds} = 360mA$  ,  $V_{gs} = -2.4V$  .

**ABSOLUTE MAXIMUM RATING**

Parameters	Symbol	Rating
Drain voltage	$V_{ds1}$	40V
Gate voltage	$V_{gs}$	-6V
Drain source current	$I_{dsq}$	0.48A
Continuous dissipation at 25°C	$P_t$	19W
Channel temperature	$T_{ch}$	200°C
Operating temperature	$T_{op}$	-55°C to +85°C
Storage temperature	$T_{sto}$	-55°C to +135°C

**SMALL SIGNAL DATA\***

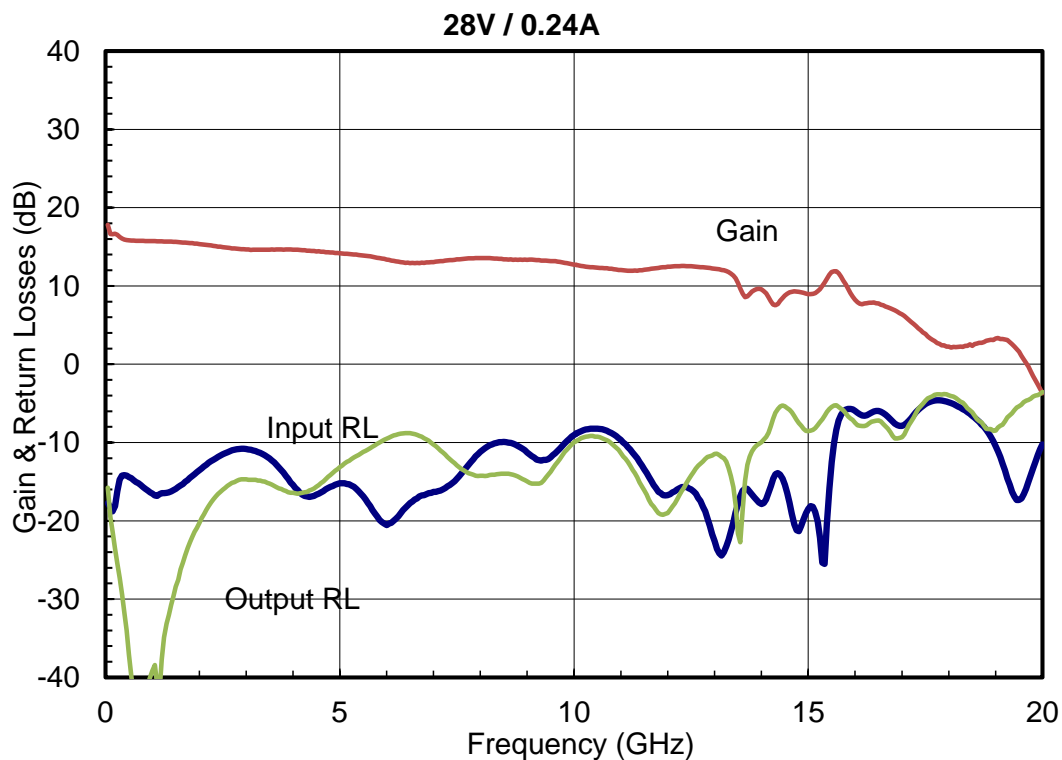

\* S-Parameters measured using test fixture. Bias is  $V_{ds1} = 28V$ ,  $I_{ds} = 360mA$ ,  $V_{gs} = -2.4V$ .

**NOISE DATA**

(TBD)

POWER DATA\*\*

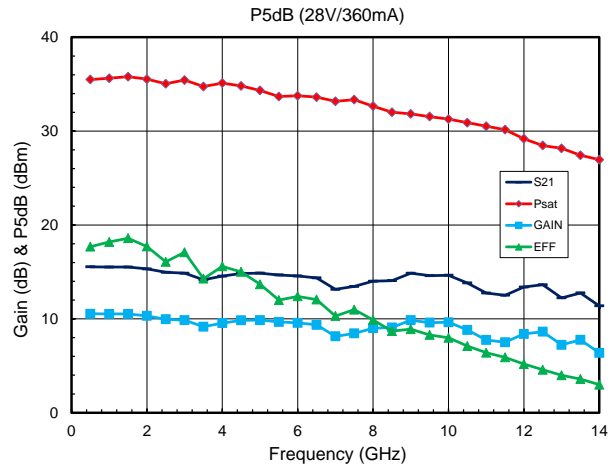
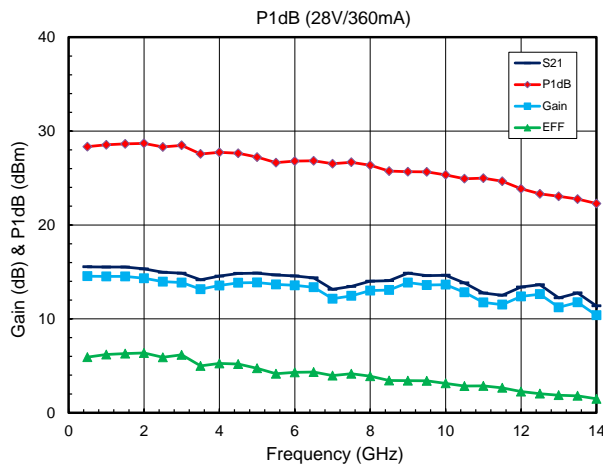

a) S21, Power, Compressed gain and efficiency at  $V_{ds} = +28V$ ,  $I_{ds} = 0.36A$ ,  $V_{gs} = -2.4V$

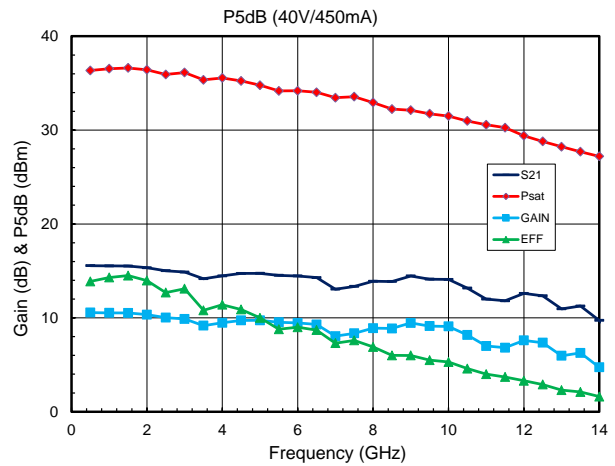
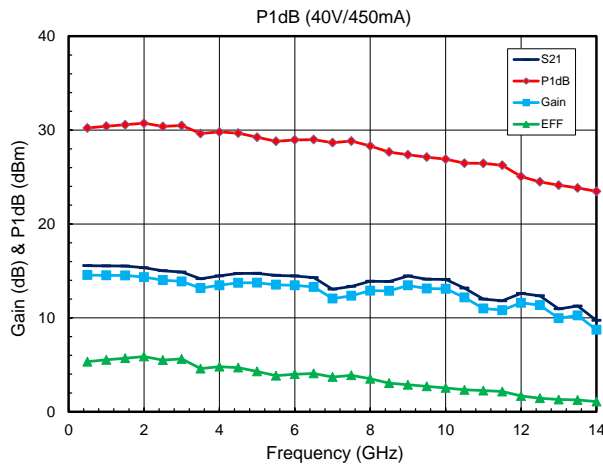

b) S21, Power, Compressed gain and efficiency at  $V_{ds} = +40V$ ,  $I_{ds} = 0.45A$ ,  $V_{gs} = -2.3V$

\*\* Power measured using test fixture and external bias tee..

PACKAGE OUTLINE

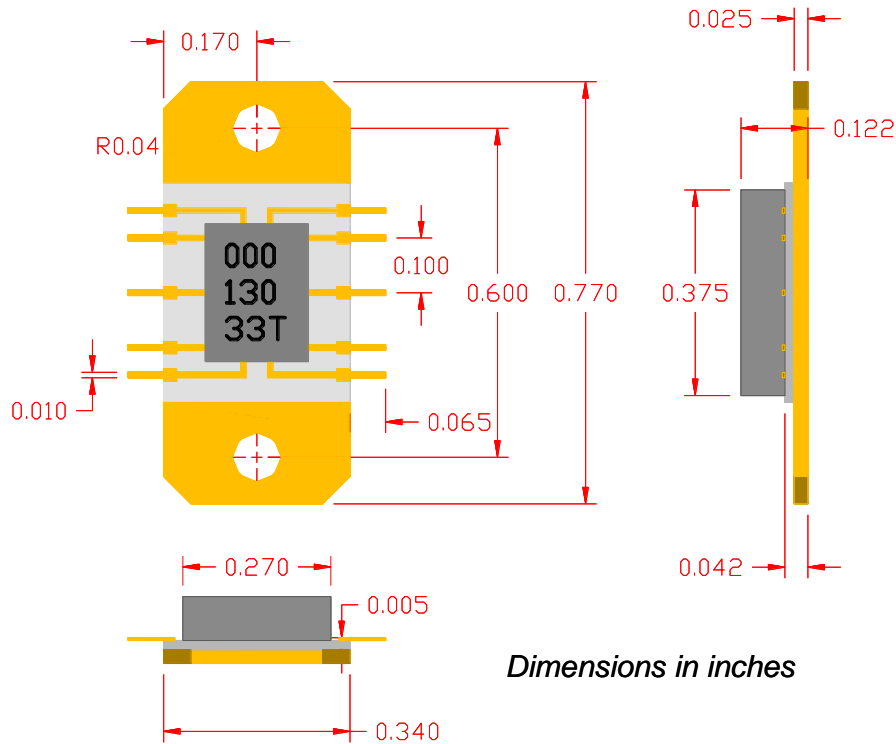

Pin Layout

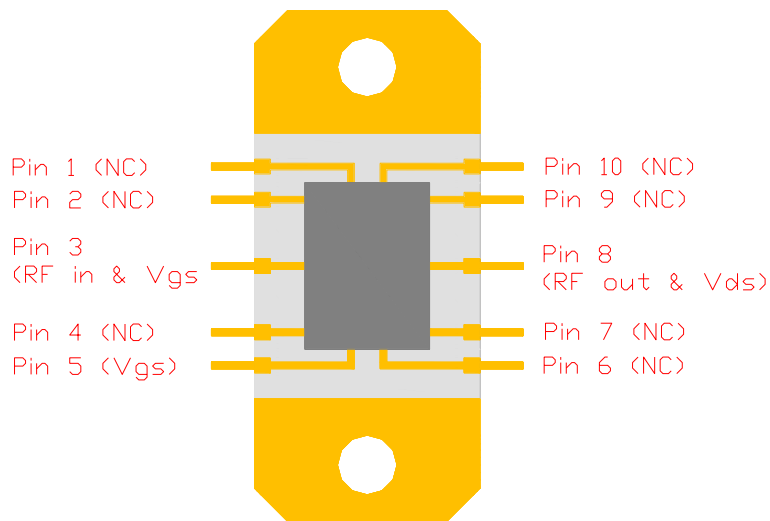

Pin No.	Function	Bias
1	NC	-
2	NC	-
3	RF in & Vds	-2.4V
4	NC	-
5	Vgs	-2.4V
6	NC	-
7	NC	-
8	RF out & Vds	+28V
9	NC	-
10	NC	-

TEST CIRCUIT

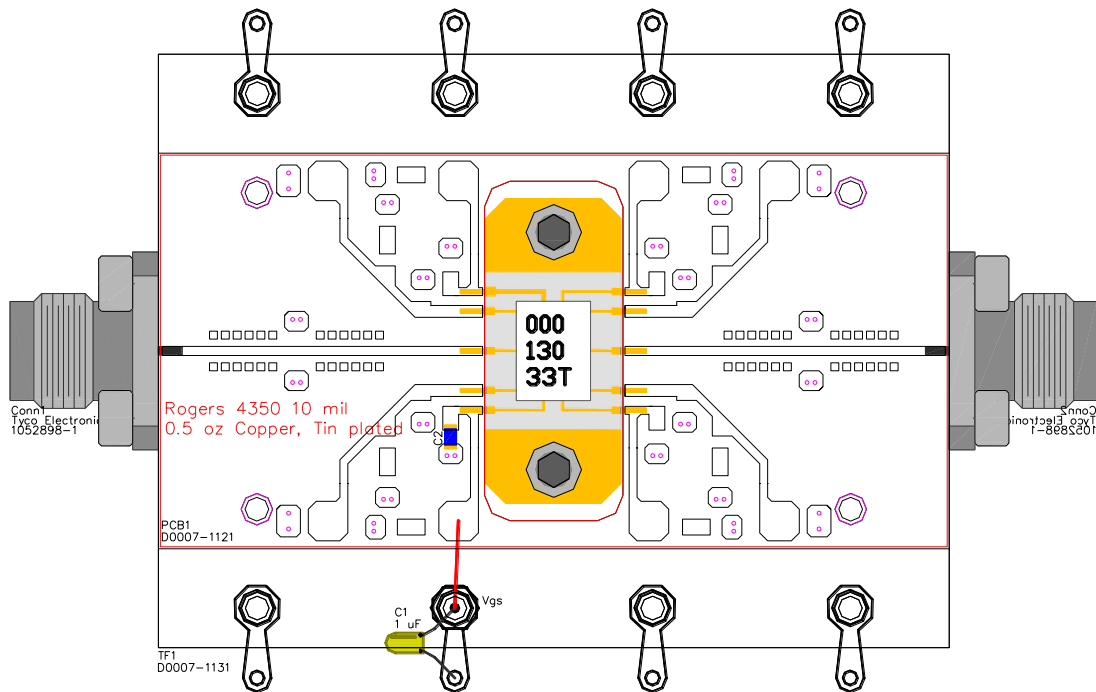

- Notes:
- 1- Use epoxy to mount PCB
  - 2- C1=1uF, C2=1000pF
  - 3- All SMT Caps & Resistors are 0603 size

Important Notes:

- 1- Recommended current bias is 360mA. Gate biases of -2.4V is for reference only.  $V_{gs}$  could be adjusted to vary the current going thru the MMIC.
- 2- Do not apply  $V_{ds}$  without proper negative voltages on  $V_{gs}$ . Otherwise MMIC would fail due to excess heat.
- 3-  $V_{ds}$  is applied through the output RF port using bias tee and similarly  $V_{gs}$  is applied using a bias tee on the input RF port. Alternatively  $V_{gs}$  could be applied on PIN 5 as shown above, in that case a DC block is required instead of the bias tee on the input RF port.